



PRODUCT DATASHEET
I-14S OVERHEAD SECTIONAL
DOOR

Copyright and Disclaimer Notice

Although the contents of this publication have been compiled with the greatest possible care, ASSA ABLOY cannot accept liability for any damage that might arise from errors or omissions in this publication. We also reserve the right to make appropriate technical modifications/replacements without prior notice.

No rights can be derived from the contents of this document.

Color guides: Color differences may occur due to different printing and publication methods.

Dynaco as word and logo are trademarks belonging to the ASSA ABLOY Group.

No part of this publication may be copied or published by means of scanning, printing, photocopying, microfilm or any other process whatsoever without prior permission in writing by ASSA ABLOY.

© ASSA ABLOY 2006-2024.

All rights reserved.

Technical Overview

Features

Max size: (W x H)	5000 x 5000 mm
Panel thickness:	42 mm
Panel material:	Microrilled steel
Filling:	CFC-free polyurethane (water blown). Reaction to fire classification according to EN13501: C-s3, d0.
Weight	13 kg/m ²
Color outside:	13 standard RAL colors
Color inside:	RAL 9002
Track types:	Standard: SL Optional: HL, VL
Windows:	Optional: DARP, TARP, DAOP, ALRB, ALBS, Framed section
Passdoor:	Not possible in the I-14S
Electrical operation:	Optional: Automated operation, Access control, Safety functions

Performance

Opening/closing speed:	Opening ≈1,0 m/s, Closing 0,7 m/s	
Life time expectations:	Door: 200000 door cycles or 10 years, when service/replacement program has been performed. Springs: 20000 door cycles, optional max.100000 depending door configuration.	
Resistance to wind load, EN12424	Insulated panel sections	Class 3 (DLW ≤ 4250) Class 2 (4250 < DLW) (Higher classes on request)
	Framed sections nr. 2 and 3	Class 3 (DLW ≤ 3650); Class 2 (3650 < DLW ≤ 4550) (Bigger DLW possible for framed in section 4 and up)
Thermal transmittance, EN12428	1,0W/(m ² ·K) full panel (Door size 5000 x 5000 mm) Thermal calculations on exact door sizes and configurations are available on request	
Resistance to Water penetration, EN12425	Class 3	
Air permeability, EN12426	Class 3	
Acoustic insulation, EN ISO 10140-2	R - 25 dB	

Contents

Copyright and Disclaimer Notice.....	2
Technical Overview.....	3
1 Description.....	6
1.1 General.....	6
1.2 Dimensions.....	6
1.2.1 Daylight width and daylight height.....	6
1.2.2 Section sizes.....	6
1.3 Door leaf.....	6
1.3.1 Construction.....	6
1.3.2 Material.....	7
1.3.3 Vertical cross-section.....	7
1.3.4 Colors.....	8
1.3.5 Seals.....	8
1.3.6 Wind reinforcement truss.....	9
1.3.7 Handle.....	9
1.3.8 Lock bolt.....	9
1.4 Balancing system.....	10
1.4.1 Safety devices.....	10
1.5 Track sets.....	11
1.5.1 General.....	11
1.5.2 SL - Standard Lift.....	11
1.5.3 HL - High Lift.....	11
1.5.4 VL - Vertical Lift.....	11
2 Available Options.....	12
2.1 Fixed sections.....	12
2.1.1 Fixed sections options.....	12
2.2 Windows.....	13
2.2.1 DARP.....	13
2.2.2 TARP.....	13
2.2.3 DAOP.....	14
2.2.4 ALRB.....	14
2.2.5 ALBS.....	14
2.2.6 Framed sections.....	14
2.2.7 Number of windows.....	14
2.2.8 Windows.....	15
2.3 Optional colors*.....	15
2.4 Cylinder lock.....	15
2.5 Collision protection.....	16
2.5.1 Track protection kit.....	16
2.5.2 Reinforced bottom profile.....	16
3 Operating system.....	17
3.1 Type of operation.....	17
3.2 C700 Door control system.....	17
3.3 IDO7S Operator.....	17
3.4 Access and automation.....	18
3.4.1 Basic control functions.....	18
3.4.2 External control functions.....	18
3.4.3 Automatic control functions.....	18
3.4.4 Safety functions.....	19
3.4.5 Additional functions.....	19
4 CEN Performance.....	20
4.1 Lifetime expectation.....	20
4.2 Resistance to windload.....	20
4.3 Resistance to water penetration.....	20
4.4 Air permeability.....	20

4.5	Thermal transmittance.....	21
4.6	Acoustic insulation.....	21
4.7	Operating forces and safe openings.....	21
5	Building and space requirements.....	22
5.1	Building preparations.....	22
5.1.1	Installation preparations.....	22
5.2	Space requirements.....	22
5.2.1	Space requirements SL.....	23
5.2.2	Space requirements HL.....	24
5.2.3	Space requirements VL.....	25
	Index.....	26

1 Description

1.1 General

The Dynaco I-14S overhead sectional speed door, with its modern, clean design, is one of the fastest and well-insulated overhead doors on the market.

With an opening speed of approximately one meter per second, the Dynaco I-14S is designed for businesses with frequently used doors, vehicles of different height, better temperature control, regular door-collisions or an interest in reducing noise and dust.

The Dynaco I-14S overhead sectional door has been designed to meet all operational and safety requirements in the European Directives and the standards issued by the European Standardization Committee, CEN.

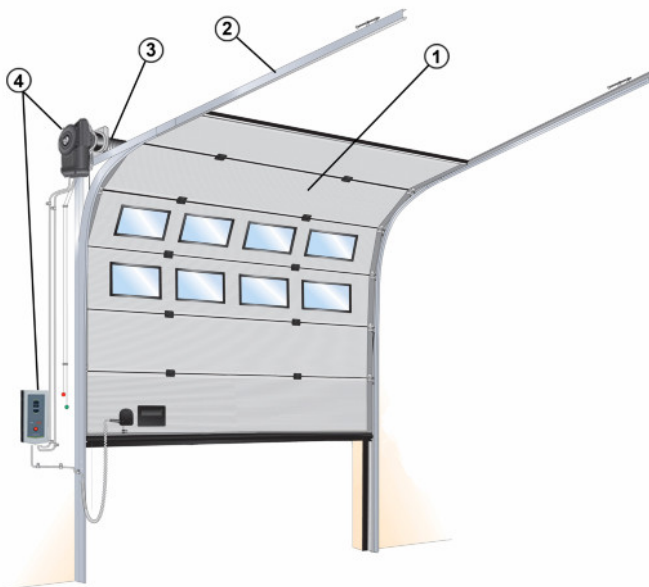

The door has 4 primary parts:

1. Door leaf
2. Track set
3. Balancing system
4. Operating system

1.2 Dimensions

1.2.1 Daylight width and daylight height

The standard Dynaco I-14S overhead sectional door is delivered in the following size range:

	Daylight width	Daylight height
Min.:	2000 mm	2750 mm
Max.:	5000 mm	5000 mm

1.2.2 Section sizes

Section height:	545 mm
Top section height:	275 - 820 mm trimcut
Thickness:	42 mm

The door leaf height is achieved by trimcutting the top section.

1.3 Door leaf

1.3.1 Construction

The Dynaco I-14S overhead sectional door leaf has horizontal sections, connected together with hinges. The outer hinges of each section have rollers that run in the tracks. The horizontal sections are insulated panels designed without thermal bridges for optimal insulation. The panels are filled with water blown CFC-free polyurethane.

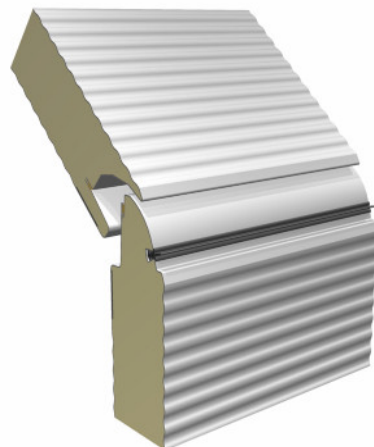

1.3.2 Material

The surface of the door leaf panels is characterized by the microrilled steel sheet. The pre-coated steel panels (steel pre-coated) for the door leaf fulfill outdoor corrosion resistance category RC3 according to EN 10169.

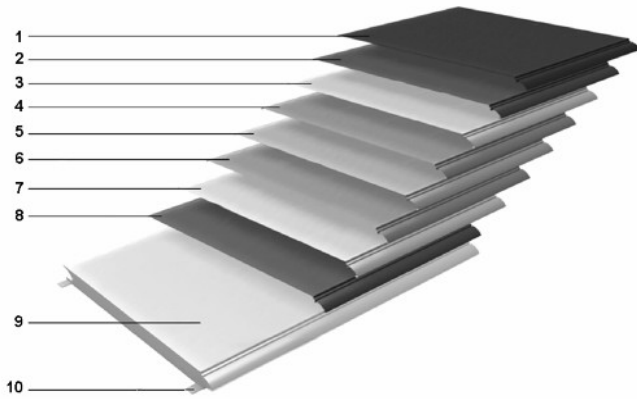

1. Polyester coating
2. Primer
3. Chromate layer
4. Zinc based metallic coating*
5. Steel sheet
6. Zinc based metallic coating*
7. Chromate layer
8. Primer
9. CFC-free polyurethane (water blown).
Reaction to fire classification according to EN13501: C-s3, d0.
10. Reinforcement strips

1.3.3 Vertical cross-section

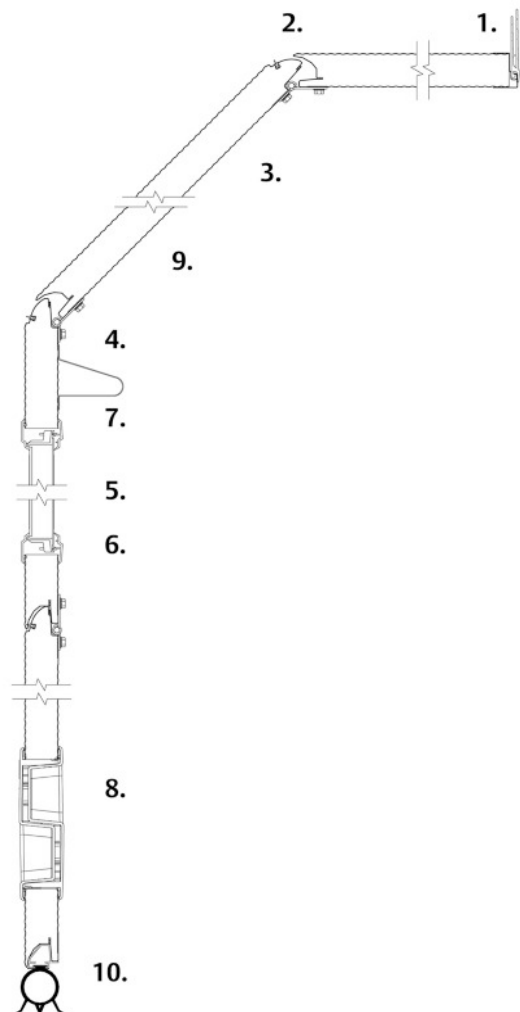













1. Top seal
2. Section joint with finger pinch protection and seals
3. Inner and outer sheet
4. Internal steel reinforcement, to provide positive fixing points
5. Window (optional)
6. High impact polystyrene frame
7. Panel truss - wind reinforcement (if necessary)
8. Step/lift handle
9. Insulation (CFC-free / water blown)
10. Bottom seal

1.3.4 Colors

The RAL-colors are as close as possible to the official RAL HR collection. Max. deviation is 1,0 DE (RAL 7016 excluded).

Pre-coated range:

	RAL 1021
	RAL 3000
	RAL 5010
	RAL 6005
	RAL 7016
	RAL 7021
	RAL 7024
	RAL 8017
	RAL 9002
	RAL 9005
	RAL 9006
	RAL 9007
	RAL 9010

1.3.4.1 Pre-coated colors

Steel

- Outside color: The steel panel is available in the 13 standard colors.
- Inside color: RAL 9002 - Grey white.

1.3.5 Seals

The door is equipped with well designed seals on all sides that gives the door its excellent sealing abilities.

1.3.5.1 Top seal

Installed on the top panel to seal the gap between the panel and the wall. The double lip EPDM rubber top seal is mounted in an ABS adapter profile for optimal insulation and tightness.

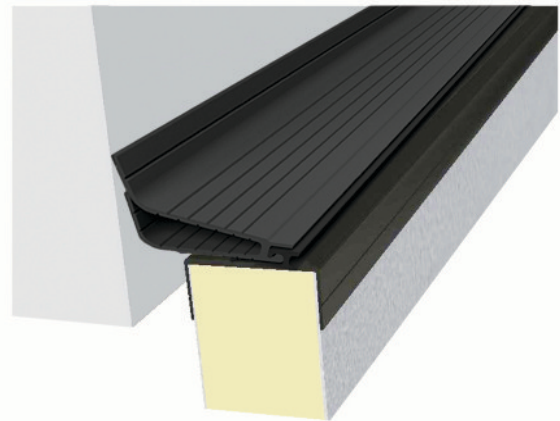

1.3.5.2 Side seal

Installed on the track set to close the gap between the tracks and the door leaf. The double lip side seal design with insulation chambers ensures an optimal insulation and sealing.

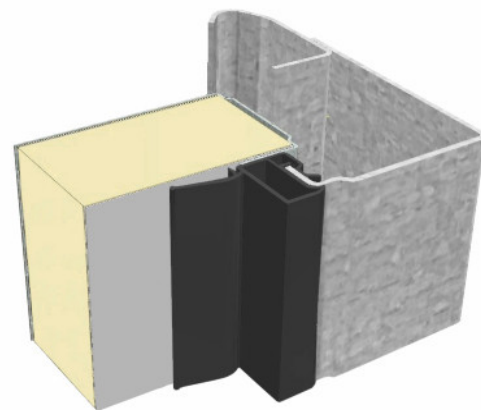

1.3.5.3 Bottom seal

Installed on the bottom edge of the bottom panel, to act as a barrier as well as a shock absorber. The flexible EPDM rubber material and the O-shape provides continuous pressure on the floor, ensuring maximum sealing. The bottom seal is mounted in an ABS adapter for optimal insulation and reduced risk of condensation.

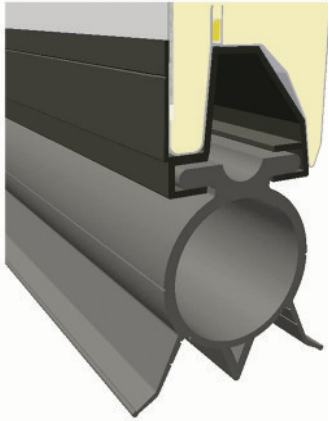

1.3.6 Wind reinforcement truss

Wider door panels and panels with windows are reinforced with metal profiles that act as trusses. These trusses reduce bending of the panel caused by wind loads or when the door leaf is in the horizontal position and is bending under its own weight. The truss is sloped to prevent objects being placed on it which could fall when the door opens. Nice plastic endcaps prevent dust being collected in the truss.

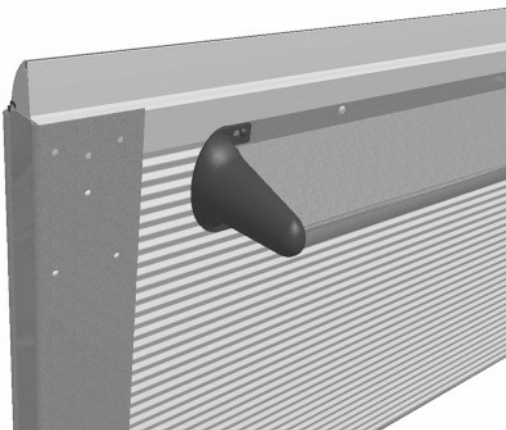

1.3.6.1 Wind reinforcement truss

For safety reasons wind reinforcements are not possible on section 1, 2 and 3.

1.3.7 Handle

For manual operation, every Dynaco I-14S overhead sectional door is provided with a solid, easy to grip and step-on handle.

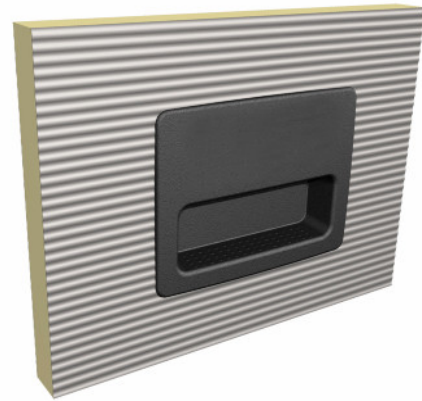

1.3.8 Lock bolt

A standard Dynaco I-14S overhead sectional door is equipped with a lock bolt. The lock bolt locks the door from the inside, without the use of a key. The lock bolt has a hole in the latch, to allow the use of a 12mm padlock.

The Lock bolt is not visible from the outside.

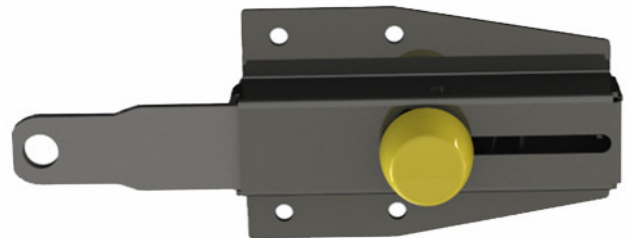

1.4 Balancing system

The balancing system balances the door by applying a force nearly equal to the weight of the door leaf. This allows the door leaf to be moved up and down manually, and to stay open in any position.

The system is installed on the top or the end of the track set and works as follows: Two torsion springs are installed on a shaft above the door opening. This shaft has a cable drum on each end from which door cables run to the bottom corners of the door leaf. Turning the shaft moves the door up or down.

1.4.1 Safety devices

The balancing system supports heavy forces. In case of a spring or cable break, its counterforce is lost. The door is therefore equipped with two safety devices that can block downward door movement:

- Spring Break Device (standard)
- Slack Rope Switch (standard)

1.4.1.1 Spring break device (SBD)

The Spring Break Device (SBD) is delivered with all Dynaco I-14S overhead sectional doors.

In the event of a spring break, the sudden drop force activates the Spring Break Device (SBD). The shaft will be locked in less than 300 mm of door movement.



1.4.1.2 Slack rope switch

The Slack Rope Switch is delivered with all Dynaco I-14S overhead sectional doors.

In the event of a cable break, the sudden drop of tension activates the Slack Rope Switch. The motor will not be able to continue to run.

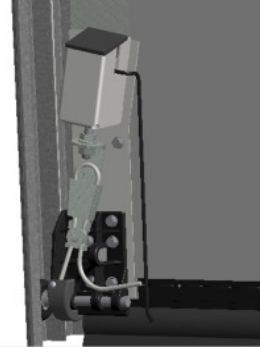

1.5 Track sets

1.5.1 General

The track set supports the door leaf on its rollers and guides it upwards. The selection of the appropriate track set is based on various factors:

- Available head room
- Door height
- Type of vehicles
- Presence of roof obstructions, pipes and overhead crane beams.

The track sets below cover most applications. Other applications are available on request.

1.5.2 SL - Standard Lift

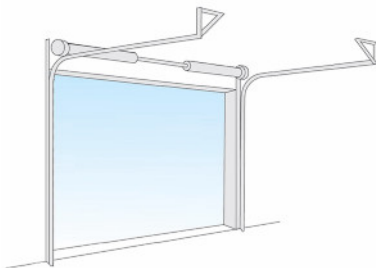

- Building type: Most standard industrial buildings.
 - Benefits: Optimal design for common buildings.
- The Standard Lift track set, with the spring package just above the door, is the most common solution

1.5.3 HL - High Lift

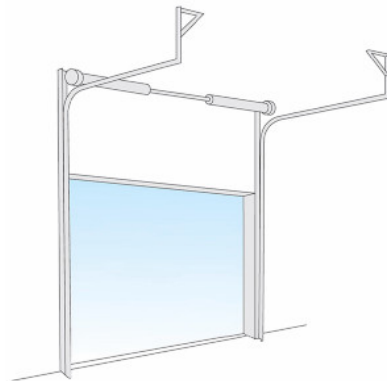

- Building type: High ceilings. On the High Lift track set the spring package is placed high above the door.
- Benefits: This track type allows high vehicles to cross along the door opening without obstructions of the horizontal tracks.

This track type is used when the space above the door is considerable, and is needed for work and traffic, e.g.: high vehicles.

1.5.4 VL - Vertical Lift

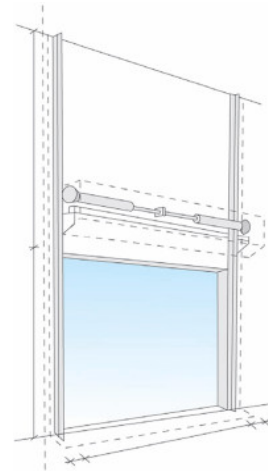

- Building type: Very high ceiling and high working space requirements.
- Benefits: Allows high vehicles to cross along the door opening without any obstructions.

If the space between the daylight height and the roof is sufficient, with this track type, the door can be opened vertically.

2 Available Options

2.1 Fixed sections

Fixed sections can advantageously fill space around new doors that are smaller than the wall opening. Fixed sections are available in top and side sections, with or without windows or passdoor. Fixed sections are supplied in the same color and construction as the door leaf.

A fixed section can be provided with a passdoor for two reasons: Safety and energy cost reduction.

- Safety: Putting a separate passdoor in a fixed section next to the industrial door separates pedestrian and vehicle traffic.
- Energy cost reduction: The opening space for frequent pedestrian traffic is minimized.

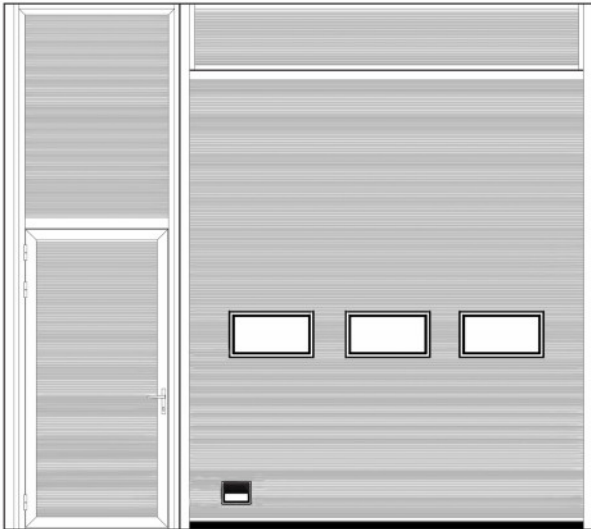

2.1.1 Fixed sections options

	Minimum size in mm (Daylight width - Daylight height)
Passdoor	800 - 2076
Side panel with passdoor (A)	800 - 2441
Side panel with passdoor (B)	1496 - 2076
Side panel with passdoor (C)	1496 - 2441
Side panel without passdoor	300 - 300
Side panel without passdoor (loose sections)	83 - 140
Top panel (loose sections)	83 - 83

	Maximum size in mm (Daylight width - Daylight height)
Passdoor	1495 - 2440
Side panel with passdoor (A)	1495 - 6000
Side panel with passdoor (B)	2400 - 2076
Side panel with passdoor (C)	2400 - 6000
Side panel without passdoor	2400 - 6000
Side panel without passdoor (loose sections)	8000 - 6000
Top panel (loose sections)	8000 - 6000

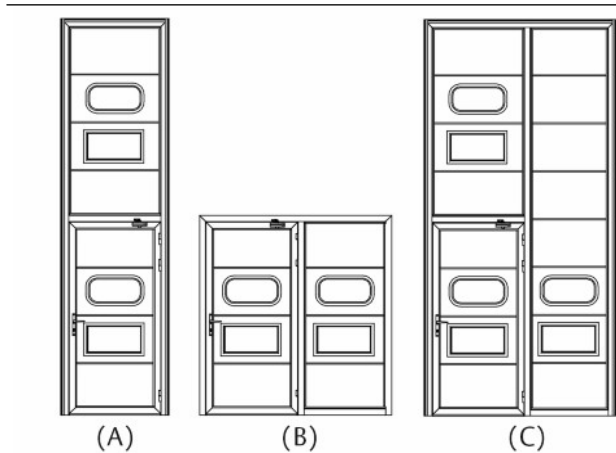

B - C available on request

2.2 Windows

The door sections can be glazed with windows*. The number of windows per section is directly related to the daylight width. Optionally, one single window can be placed on the outer left or right side, in the third section.

*The bottom section cannot be glazed.

2.2.1 DARP

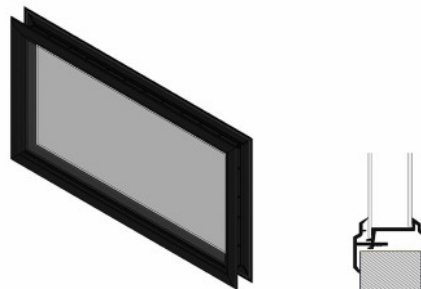

- Double layer Acrylic (3 + 2 mm), Rectangular, in Plastic frame
- Light opening: 604 x 292 mm
- Window frame: Black

2.2.2 TARP

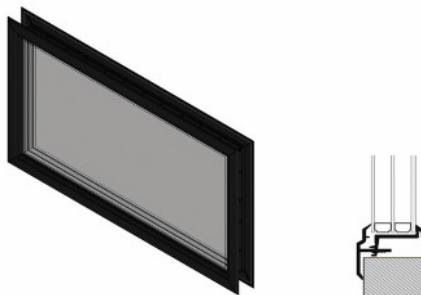

- Three layer Acrylic (3 + 3 + 2 mm), Rectangular, in Plastic frame
- Light opening: 604 x 292 mm
- Window frame: Black

2.2.3 DAOP



- Double layer Acrylic (3 + 2 mm), Oval, in Plastic frame
- Light opening: 610 x 292 mm
- Window frame: Black

2.2.4 ALRB



- Aluminum Layer Rectangular Burglar, double layer (6+6 mm) in aluminum frame
- Light opening: 578,5 x 268,5 mm
- Burglar Resistance Class 2

2.2.5 ALBS



- Aluminum Layer Burglar Small, double layer (6+6 mm) in aluminum frame
- Light opening: 578,5 x 146,5 mm
- Burglar Resistance Class 2

2.2.6 Framed sections

The Dynaco I-14S overhead sectional door can be fitted with framed sections. The bottom section is always insulated. The height of the framed sections is 545mm. Only the top-section can have a variable height. For safety reasons, the width of the sections is limited, depending on wind load. For class 3 wind load resistance, trussed profiles are needed. In sections 1, 2 and 3 trussed profiles are never allowed. The glass weight is limited to 12kg/m². For more details please refer to the relevant documentation or contact Dynaco.



2.2.7 Number of windows

For windows the daylight width is divided into a fixed grid. The number of windows depends on the daylight width of the door. The number of windows is listed in the table. Optional: a single window in the center or at the left or right side of the section.

For safety reasons windows are limited in section 2 and 3 at a DLW \geq 4050 mm. For details contact Dynaco.

Windows

No. of windows	Daylight width
1	2050 - 2134 mm
2	2135 - 2999 mm
3	3000 - 3864 mm
4	3865 - 4729 mm
5	4730 - 5000 mm

2.2.8 Windows

DARP/TARP/ALRB/ALBS

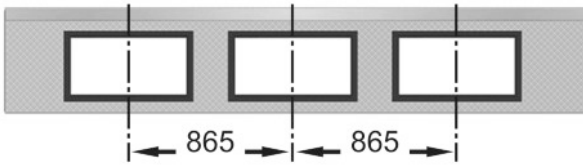

DAOP

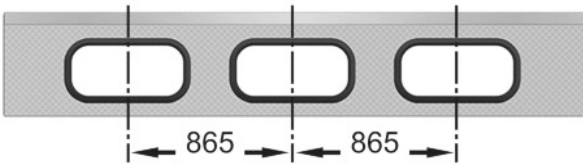

2.3 Optional colors*

Factory painting

The door leaf can be factory painted in any RAL and NCS color plus some metallic colors, outside only. The painting can be applied to only the panel or to the complete door leaf, including frames and strips.

Panel only

Complete

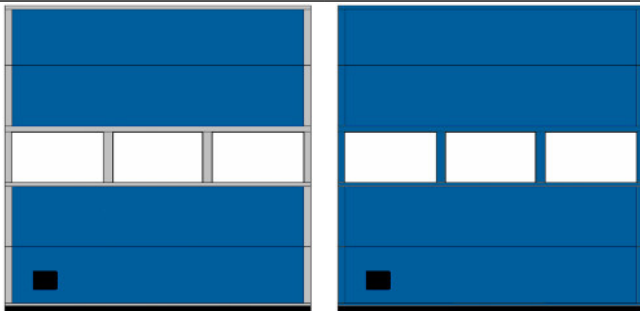

* Other colors available on request

2.4 Cylinder lock

The Cylinder lock is a key operated lock which offers extra security. The lock is installed on the inside and can be unlocked with a key and turning the handle. Access to the Cylinder lock is possible from either only the inside, or both the inside and the outside.



2.5 Collision protection

2.5.1 Track protection kit

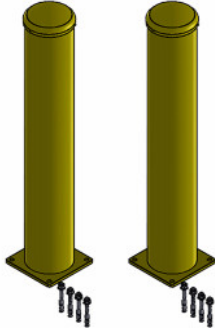

The track protection kit is designed to protect the tracks being accidentally hit by vehicles. The kit includes two bollards and fasteners. The bollards are powder coated with a UV protective paint and the top can be removed to fill the bollard with sand or concrete. The bollards are 1000 mm high with a diameter and thickness of 159×3 mm and the plate is 200 mm square. The distance between (any part of) the door and the bollards should be at least 500 mm to prevent people from getting stuck between the bollards and the door.

2.5.2 Reinforced bottom profile



A special aluminium bottom profile with an integrated reinforcement is available if extra collision protection is needed.

3 Operating system

3.1 Type of operation

An Dynaco I-14S overhead sectional door is always electrically operated. If needed the door can be opened and closed manually. Electrically operated doors can be controlled by hand or be fully automatic.

The Dynaco I-14S overhead sectional door will be supplied with a high performance electrical operating system. This operating system gives access to the full program of Access and Automation functions, that can fulfill many operational needs, related to traffic type and frequency, door weight and temperature control.

3.2 C700 Door control system

The C700 Door control system is one of the most advanced control units that is prepared for one or more physical upgrades from the entire range of automation systems. An automation system allows door operation by sensors or remote control.

This control unit contains a 3-digit diagnostics display that allows efficient troubleshooting and displays the number of door cycles. Together with the service indicator, this extra feature allows advanced maintenance planning to users where the door is an essential element of internal logistics.



- Standard actuator UP-STOP-DOWN and pulse control
- Self monitoring light grid.
- Automatic closing after set period 0-240s.

3.3 IDO7S Operator

A main part of the system is the IDO7S operator: an electric motor which drives the balancing shaft with the cable drums and torsion springs. The IDO7S operator is mounted directly on the balancing shaft.

Key features:

- Smooth and silent
- Soft start and soft stop
- Shaft: ø35 mm tube



	IDO7S Operator
Voltage supply: +/- 10%	230V AC, +/- 10% 1-phase 50/60Hz
Power:	0,55 kW
Degree of protection:	IP65, with CEE plug, IP 44
Allowed door weight, max.:	300 kg
Temperature working range:	-20°C to +55°C*
Operating factor:	ED = 30% S3 10 min. intermittent
Mounting preparations:	When installing on the wall, an extra attachment angle is required with > 500N per fixation point.

* At low temperatures the first few cycles may be run with reduced speed to prolong the operator's lifetime. Can be equipped with a heater for a working range down to -30°C.

3.4 Access and automation

Dynaco offers a wide range of functions that allows advanced opening and safety control. Please refer to the specification sheet of the control units to see which functions apply to which models.

3.4.1 Basic control functions

3.4.1.1 Interlocking

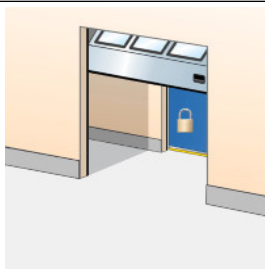

Developed for climate control or safety; If door A is open, door B cannot be opened. If door B is open, door A cannot be opened. An interlocked door can remember an up-command, if selected via a micro switch.

3.4.1.2 Reduced opening

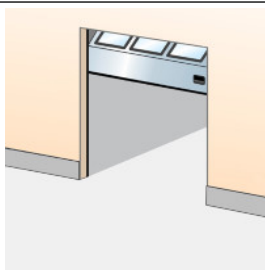

When it is unnecessary or undesirable to fully open a door, an additional switch can be used to open the door to a pre-programmed reduced opening position.

3.4.2 External control functions

3.4.2.1 External push button box

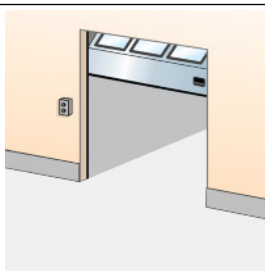

An extra control box is installed outside the building or inside close to the door if the main control unit needs to be installed away from the door opening. Installed on the inside or outside wall beside the door.

3.4.2.2 Pull-rope switch

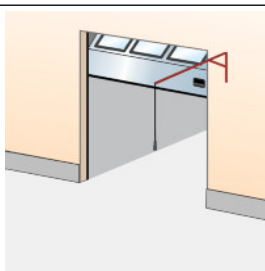

A pull-rope switch above the door opening can be operated from e.g. a forklift truck. Pulling the rope opens a closed door or closes an opened door. Installed on the inside construction above the door.

3.4.2.3 Remote control

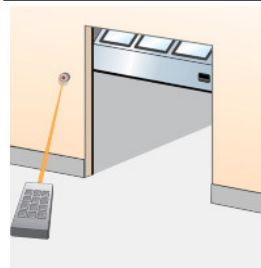

A hand-held radio transmitter allows door operation from a vehicle or any position within 50-100 meters from the receiver and aerial at the door. For closing, the door can be provided with a photocell beam. Receiver installed in control unit, antenna installed on the wall beside the door.

3.4.3 Automatic control functions

3.4.3.1 Magnetic loop

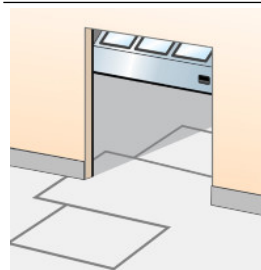

A sensor in the floor detects a metal object (usually forklift trucks, pallet trucks) and opens the door automatically. This is an ideal solution for frequent vehicle traffic. Installed on the outside, inside or both sides of the door in the floor.

3.4.3.2 Radar

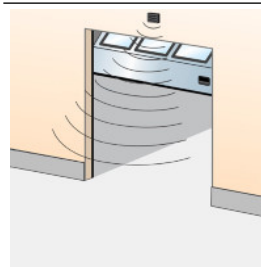

An infrared sensor above the door detects an object (person, vehicle) within a specified distance from the door and opens the door automatically. This is an ideal solution for frequent vehicle or personal traffic. Often combined with automatic closing. Installed on the inside or outside wall above the door.

3.4.3.3 Photocell open door

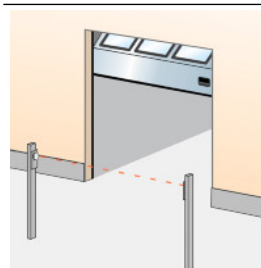

A set of photocells on pillars, on each side of the door. When a person or vehicle passes between the photocells, the beam is interrupted and the door opens. Photocells installed on pillars, away from the door.

3.4.3.4 Automatic closing

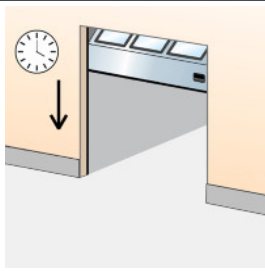

A programmable timer that closes the door after a specified time, counted from either the fully open position and/or from passing through the photocell beam.
Adjustable micro switches in control unit.

3.4.4.4 Warning lights - Green

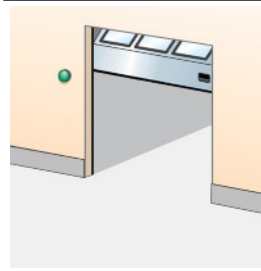

One or two green warning lights indicating the open position of the door by continuous light signal.
Installed on the inside and/or outside wall beside the door.

3.4.4 Safety functions

3.4.4.1 Safety photocells 1-channel

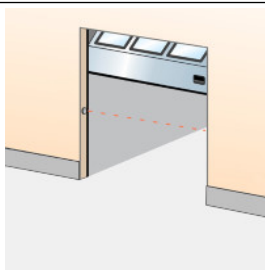

A set of a photocell transmitter and receiver is installed in the door opening. If the photocell beam is interrupted during closing, the door will stop and reverse to the fully open position.
Installed in the door opening.

3.4.4.5 Traffic lights - Red & Green

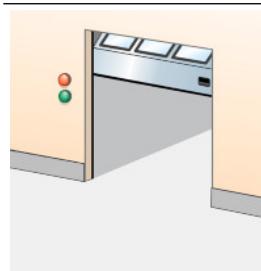

If traffic through a door needs to be directed; two red and two green traffic lights can be installed to indicate traffic direction. From the side where a vehicle is first detected to approach the door, the green traffic light comes on. The opposing side shows a red traffic light. Traffic from this direction must give way to the other.
Usually installed in e.g. parking garages.
Installed on the inside and outside wall beside the door.

3.4.4.2 Light curtain

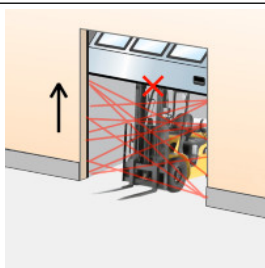

The speed door is standard equipped with a light curtain. These strips of photocells in the tracks detect any obstruction under a closing door and reverse the door.

3.4.5 Additional functions

3.4.5.1 UPS battery backup



When mains failure cannot be permitted or an increased risk of mains failure is predicted, the UPS battery backup system can be installed to store enough energy for 5 door cycles.
Installed on the inside wall beside the door.

3.4.4.3 Warning lights - Red

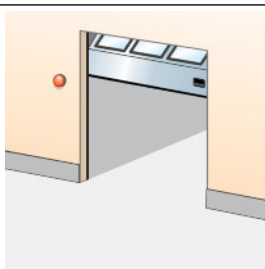

Two red warning lights giving information on the current door behaviour. Flashing light before or during door movement.
Optional: Continuous light before and during door movement.
Installed on the inside and outside wall beside the door.

3.4.5.2 Relay box



A sealed connection box makes it possible to safely connect external high-voltage equipment.

4 CEN Performance

4.1 Lifetime expectation

Door: 200000 door cycles or 10 years, when service/replacement program has been performed.
Springs: 20000 door cycles, optional max.100000 depending door configuration.

4.2 Resistance to windload

EN12424		
Test result		Class 3
Class	Pressure Pa (N/m ²)	Specification
0	-	No performance determined
1	300	
2	450	
3	700	
4	1000	
5	> 1000	Exceptional : Agreement between manufacturer and supplier

4.3 Resistance to water penetration

EN12425		
Test result		Class 3
Class	Pressure Pa (N/m ²)	Specification
0	-	No performance determined
1	30	Waterspray for 15 minutes
2	50	Waterspray for 20 minutes
3	> 50	Exceptional : Agreement between manufacturer and supplier

4.4 Air permeability

EN12426	
Test result	Class 3
Class	Air permeability dp at a pressure of 50 Pa (m ³ /(m ² ·h))
0	-
1	24
2	12
3	6
4	3
5	1,5
6	Exceptional : Agreement between manufacturer and supplier

4.5 Thermal transmittance

EN12428

Thermal transmittance	1,1W/(m ² ·K) full panel (Door size 4050 x 4250 mm)
	1,0W/(m ² ·K) full panel (Door size 5000 x 5000 mm)

(Door size 5000mm x 5000mm)

4.6 Acoustic insulation

ISO 10140-2

Acoustic insulation *	R - 25 dB
-----------------------	-----------

* Door surface 4000 x 2500 mm, no passdoor (for other sizes it can differ)

4.7 Operating forces and safe openings

EN12453 & EN12604	Crushing force N	Crushing force N	Crushing force N
Opening gap mm	200 mm from lateral border right from outside	In the middle of the door opening	200 mm from lateral border left from outside
50 mm	passed	passed	passed
300 mm	passed	passed	passed

The crushing force is the force needed for the safety edge to be activated. The maximum force allowed, according to EN12453 safety in use of power operated doors is 400 N within a maximum period of time of 0.75s. With standard light curtain there is no crushing force.

5 Building and space requirements

5.1 Building preparations

5.1.1 Installation preparations

The Dynaco I-14S overhead sectional door is shipped in parts and installed on-site. All necessary installation material is included. For every track type Dynaco offers specific installation kits to position the door in the building facade.

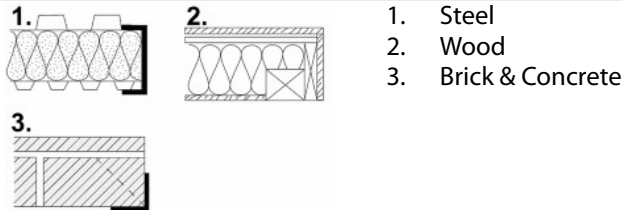

We would advise the following doors to be installed on a frame (e.g. 80×40×2 mm tubes; 100×40×2 mm for 3" tracks), equipped with an A-65 top seal.

- Doors DLW ≥ 4050 mm (aluminium or with a dark outside color frequently facing the sun). The dark outside color rule only applies to HL and VL hardware.

5.2 Space requirements

DLH	= Daylight Height	The height of the clear opening
DLW	= Daylight Width	The width of the clear opening
D	= Depth	The space between the inner side of the wall and the end of the horizontal track construction
h	= Excess height	The extra space required above the daylight height.
SL	= Side space Left	The space required for tracks beside the daylight width.
SR	= Side space Right	The space required for tracks beside the daylight width.

The grey marked area in the illustrations shows the free space required by door movement. Extra space requirements for electrically operated doors are stated in the operator specifications.

5.2.1 Space requirements SL

DLW	≤ 5000 mm
DLH	≤ 5000 mm
h	510 mm
SL/SR	165 mm, 315 mm on operator side
D	DLH + 600 mm

For details see the specific building preparation drawings.

Side and top view

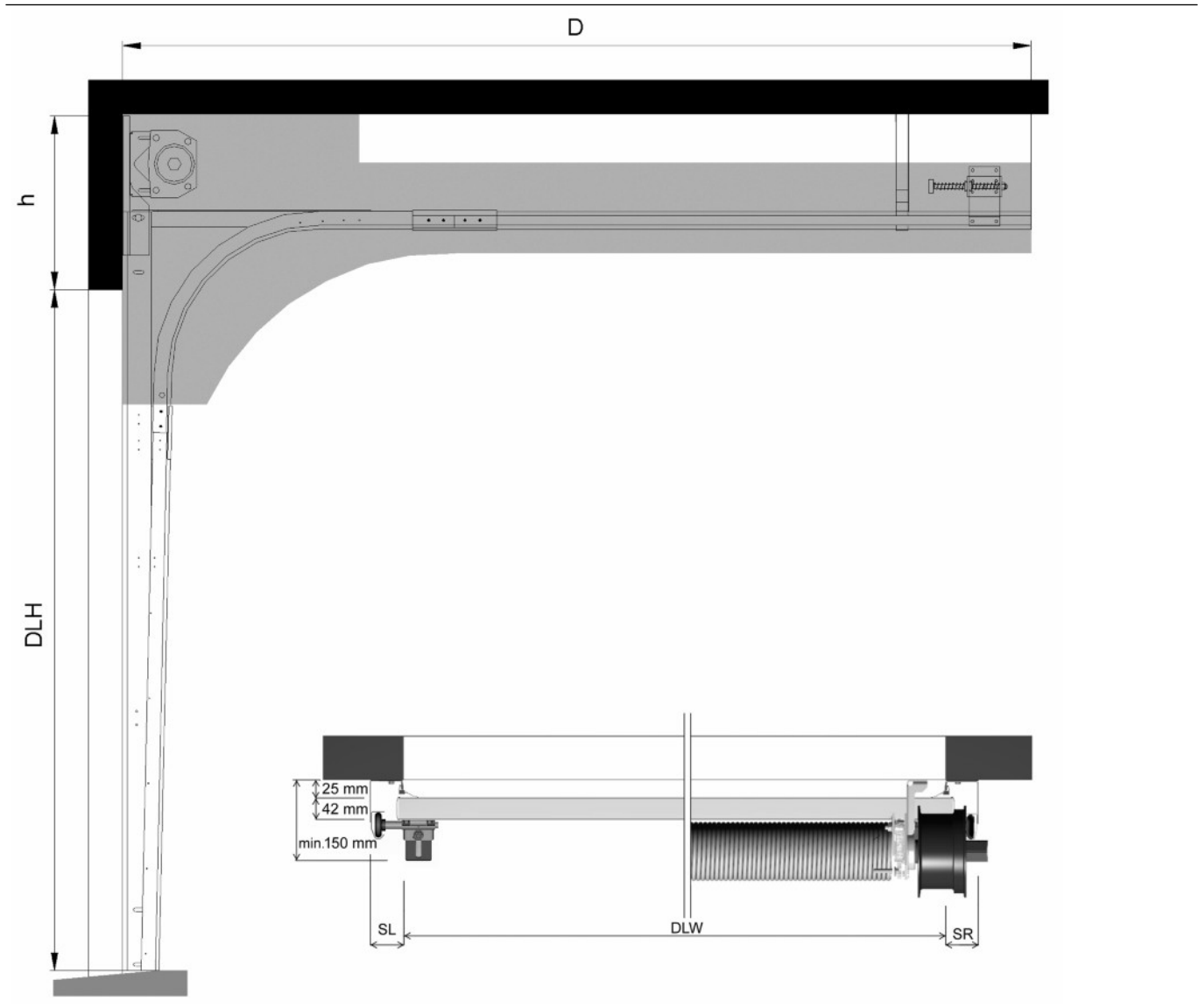

5.2.2 Space requirements HL

DLW	≤ 5000 mm
DLH	≤ 5000 mm
h	HL + 370 mm
SL/SR	165 mm, 315 mm on operator side
D	DLH - HL + 950 mm

For details see the specific building preparation drawings.

Side and top view

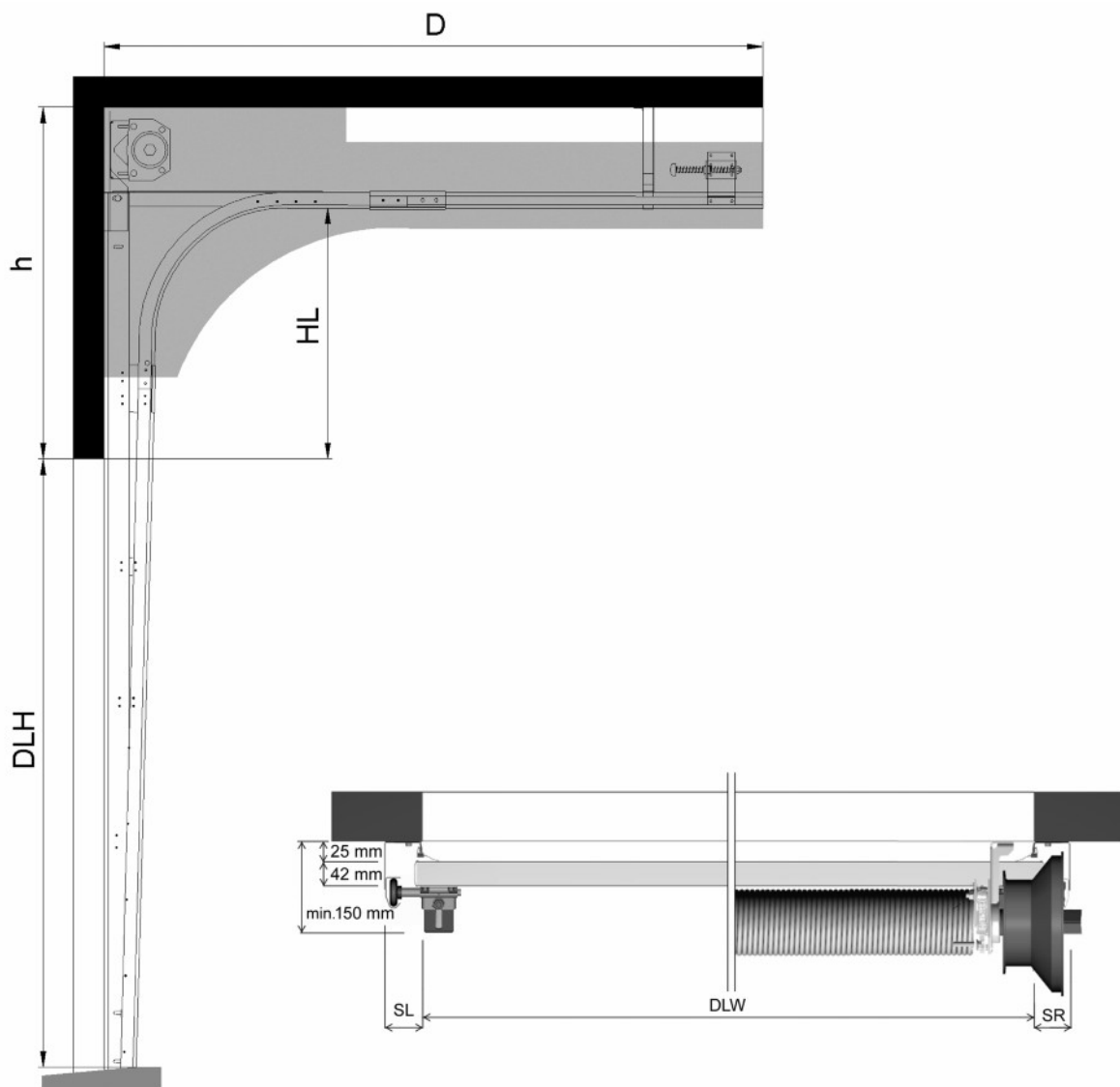

5.2.3 Space requirements VL

DLW	≤ 5000 mm
DLH	≤ 5000 mm
h	DLH + 560 mm
SL/SR	165 mm, 376 mm on operator side
D	VLS = 525 mm

For details see the specific building preparation drawings.

Side and top view

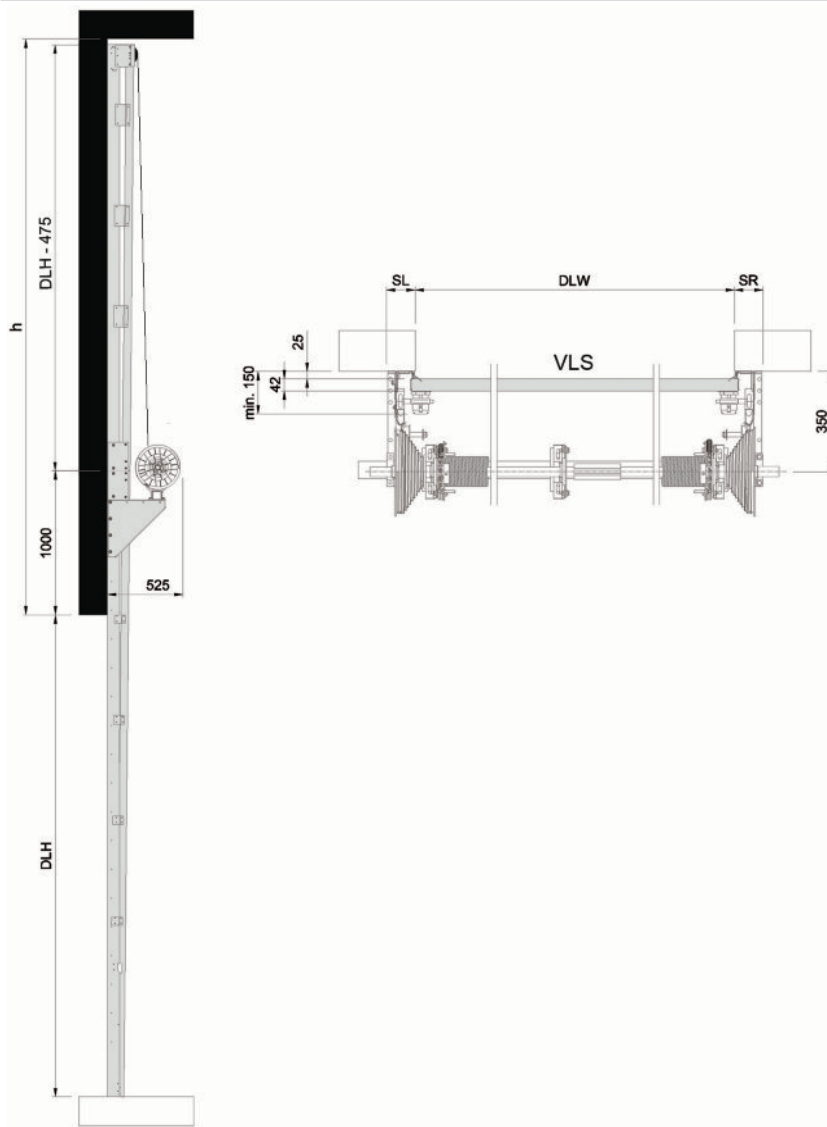

Index

A

Access and automation.....	18
Acoustic insulation.....	21
Additional functions.....	19
Air permeability.....	20
ALBS.....	14
ALRB.....	14
Automatic closing.....	19
Automatic control functions.....	18
Available Options.....	12

B

Balancing system.....	10
Basic control functions.....	18
Bottom seal.....	9
Building and space requirements	22
Building preparations.....	22

C

C700 Door control system.....	17
CEN Performance.....	20
Collision protection.....	16
Colors.....	8
Construction.....	6
Copyright and Disclaimer Notice..	2
Cylinder lock.....	15

D

DAOP.....	14
DARP.....	13
Daylight width and daylight height	6
.....	6
Description.....	6
Dimensions.....	6
Door leaf.....	6

E

External control functions.....	18
External push button box.....	18

F

Features.....	3
Fixed sections.....	12
Fixed sections options.....	12
Framed sections.....	14

G

General.....	6
General.....	11

H

Handle.....	9
HL - High Lift.....	11

I

IDO7S Operator.....	17
Installation preparations.....	22
Interlocking.....	18

L

Lifetime expectation.....	20
Light curtain.....	19
Lock bolt.....	9

M

Magnetic loop.....	18
Material.....	7

N

Number of windows.....	14
------------------------	----

O

Operating forces and safe openings	21
.....	21
Operating system.....	17
Optional colors*.....	15

P

Performance.....	3
Photocell open door.....	18
Pre-coated colors.....	8
Pull-rope switch.....	18

R

Radar.....	18
Reduced opening.....	18
Reinforced bottom profile.....	16
Relay box.....	19
Remote control.....	18
Resistance to water penetration.	20
Resistance to windload.....	20

S

Safety devices.....	10
Safety functions.....	19
Safety photocells 1-channel.....	19
Seals.....	8
Section sizes.....	6
Side seal.....	8
SL - Standard Lift.....	11
Slack rope switch.....	10
Space requirements.....	22
Space requirements HL.....	24
Space requirements SL.....	23
Space requirements VL.....	25
Spring break device (SBD).....	10

T

TARP.....	13
Technical Overview.....	3
Thermal transmittance.....	21
Top seal.....	8
Track protection kit.....	16
Track sets.....	11
Traffic lights - Red & Green.....	19
Type of operation.....	17

U

UPS battery backup.....	19
-------------------------	----

V

Vertical cross-section.....	7
VL - Vertical Lift.....	11

W

Warning lights - Green.....	19
Warning lights - Red.....	19
Wind reinforcement truss.....	9,9
Windows.....	13, 15



Product datasheet
I-14S Overhead sectional door



DYNACO EUROPE NV
Waverstraat 21
B-9310 Moorsel-Aalst (Belgium)
Tel. +32 53 72 98 98
Fax. +32 53 72 98 50

Info@dynacodoor.com www.dynacodoor.com

2024-01

About Dynaco

Dynaco is the world leader in high-speed door technology. It offers state of the art solutions for both commercial and industrial applications.

Founded in 1987, Dynaco has acquired an extensive expertise in high performance doors. Yet it continues to invest in order to exceed your expectations of quality and performance. A network of certified and dedicated partners ensures an optimal service to customers all over Europe.

Worldwide, we rely on our license partners in Russia, Japan, Vietnam and Brazil.

Dynaco is part of the ASSA ABLOY Group, the world leader in access solutions. Every day, we help billions of people experience a more open world.