

PEDESTRIAN AUTOMATIC DOORS

EVOLUS
EVOLUS-T



EN

USER MANUAL



EVOLUS

RECTILINEAR AUTOMATIC SLIDING DOOR

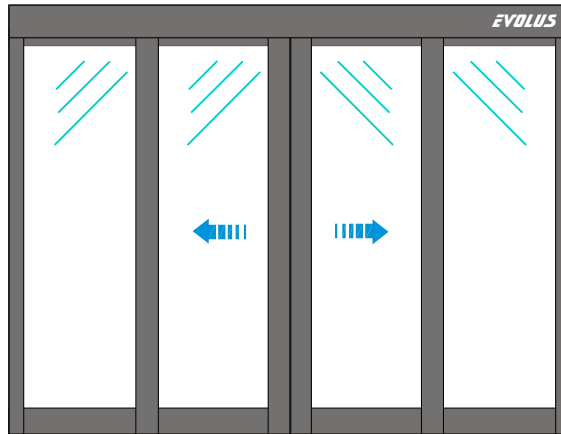

EVOLUS-T

TELESCOPIC AUTOMATIC SLIDING DOOR

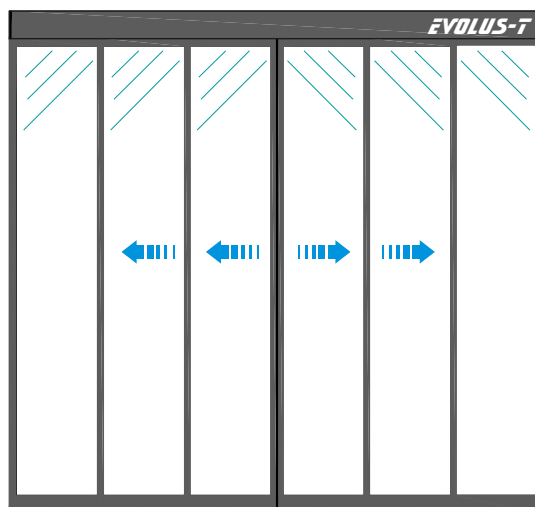

RECOMMENDATIONS

THIS INSTRUCTION MANUAL IS INTENDED FOR THE FINAL USER OF A LABEL AUTOMATIC SLIDING DOOR SYSTEM; IT IS UNDERSTOOD THAT INSTALLATION AND TESTING MUST HAVE BEEN CARRIED OUT BY SPECIALISED PERSONNEL.

GENERAL SAFETY WARNINGS



Before commissioning the automatic door please carefully read this manual.

PROVISIONS

The automatism has been designed to be used exclusively with pedestrian automatic doors.

The manufacturer accepts no responsibility for incorrect product usage, as well as for any damages arising from changes to the system made without his prior consent.

When operating the system accident prevention regulations must be observed.

REMARKS

Always meet the usage and maintenance conditions provided for by LABEL.

Maintenance and repair operations must only be performed by qualified and properly trained personnel.

PROPER BEHAVIOUR

Only use the automatic door if it is in perfect technical conditions.

In case of failure or malfunction that might affect safety immediately contact the service centre.

Inappropriate use of the system may cause serious injuries and damage.

TABLE OF CONTENTS:

1	- INDICATIVE SYSTEM DESCRIPTION	page	5
2	- EVOLUS/EVOLUS-T TECHNICAL DATA		6
3	- AUTOMATIC DOOR OPERATION		6
3.1	- NORMAL DOOR OPERATION		6
3.2	- DOOR OPERATION IN NIGHT LOCK MODE		6
4	- SELECTING THE EVOLUS - EVOLUS-T WORK PROGRAM		6
4.1	- DIGITAL PROGRAMMER EV-SDEL		7
4.2	- MECHANICAL KEY SELECTOR EV-MSEL		10
5	- OPERATION IN CASE OF POWER SUPPLY FAILURE EVOLUS - EVOLUS-T		11
6	- NOTIFICATION OF ERRORS AND OPERATION PROBLEMS		13
7	- MAINTENANCE		14
8	- DISPOSAL		14

1 - INDICATIVE SYSTEM DESCRIPTION

- ① **AUTOMATION**
- ② **MOTION SENSOR (internal and external radar)**
- ③ **EMERGENCY OPENING BUTTON**
- ④ **PROGRAM SELECTOR**
- ⑤ **SAFETY PHOTOCELLS**
- ⑥ **EXTERNAL KEY BUTTON**
- ⑦ **MANUAL EMERGENCY RELEASE (only if the the electric lock is installed)**

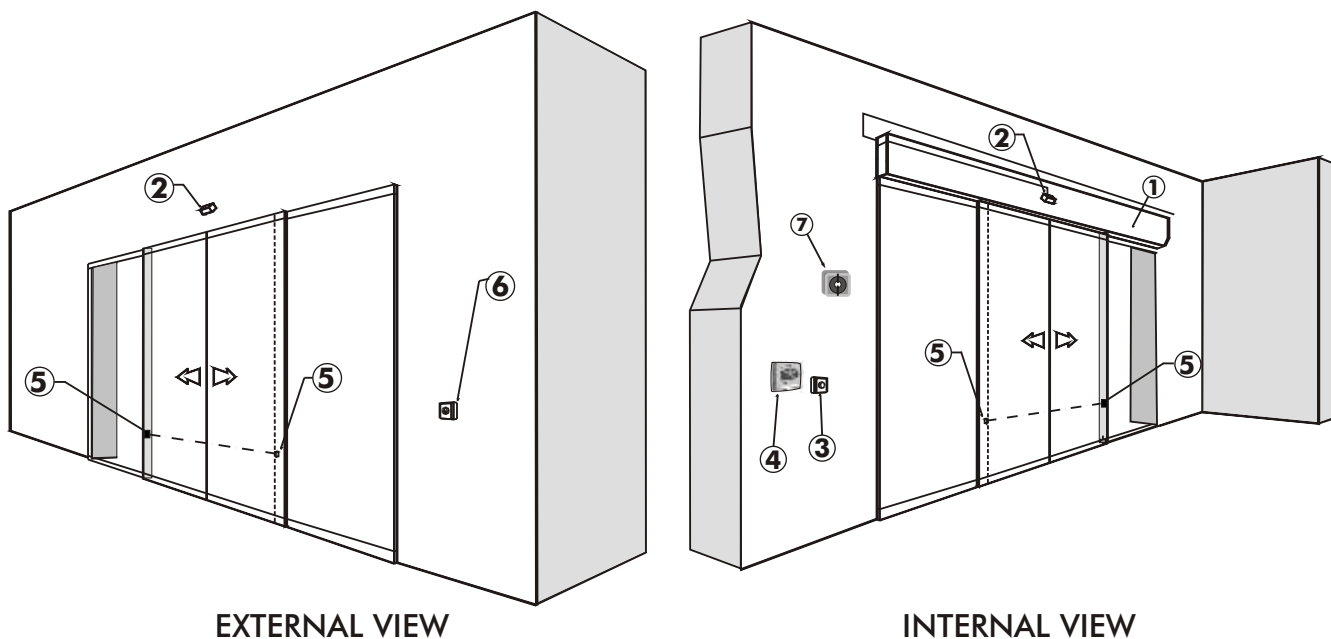

2 - EVOLUS/EVOLUS-T TECHNICAL DATA

EVOLUS MODEL	EVOLUS-90/2	EVOLUS-90/1	EVOLUS-150/2	EVOLUS-150/1		
MAXIMUM WEIGHT OF DOOR WING	90 Kg	130 Kg	150 Kg	200 Kg		
EVOLUS CROSSPIECE DIMENSIONS	120 x 150 x maximum length 6500 mm					
EVOLUS-T MODEL	EV-200DTEL	EV-200TELDX	EV-200TELSX	EV-300DTEL	EV-300TELDX	EV-300TELSX
MAXIMUM WEIGHT OF DOOR WING	50 Kg	100 Kg	100 Kg	75 Kg	150 Kg	150 Kg
EVOLUS T CROSSPIECE DIMENSIONS	120 x 210 x maximum length 6500 mm					
POWER SUPPLY	230V ac +/- 10%, 50-60 Hz					
POWER	80W (mod. 90)			130W (mod. 150)		
OPENING SPEED	max 70 cm/s (per leaf)					
CLOSING SPEED	max 60 cm/s (per leaf)					
WORK TYPOLOGY	Continuous 100%					
WORKING TEMPERATURE	- 20° C / + 50° C					
PROTECTION DEGREES	IP22					
ELECTRIC MOTOR	40 Vdc with ENCODER					
POWER SUPPLY OF EXTERNAL ACCESSORIES	13 Vdc					

3 - AUTOMATIC DOOR OPERATION

WARNING!!

Always contact the assistance technician before commissioning the door, to learn how the automation works.

Switch on the power supply by means of the system switch.

The automation electronic control unit beeps shortly to indicate that the automatic door is powered.

The first opening command starts a calibration cycle during which the door wing opening speed is very low until the end of the stroke, to find the stop points; after the delay set for the open door pause has elapsed, the wings close back at normal speed.

3.1 - NORMAL DOOR OPERATION

- ◆ When something enters the motions sensor (internal and/or external radar) detection area the door opens and stays open until sensors detect the presence, then once the pause delay has elapsed the door closes back.
- ◆ When the manual door opening button is pressed the door opens and stays open until the command remains active, then once the pause delay has elapsed it closes back.
- ◆ When something interrupts the safety photocell rays during closing, the door immediately reopens and stays open as long as the photocell remains engaged.
- ◆ If during the opening motion the door bumps against an obstacle, it stops and closes back. When it opens again, later, it slows down near the point where it had met the obstacle, to avoid further impact.
- ◆ If during the closing motion the door bumps against an obstacle, it stops and opens back. When it closes again, later, it slows down near the point where it had met the obstacle, to avoid further impact.

3.2 - DOOR OPERATION IN NIGHT LOCK MODE

- ◆ The door cannot be opened through the motion sensors (radar).
- ◆ The door may only be opened by activating the emergency opening button (if the control unit has been suitably programmed).
- ◆ The safety function (photocells and behaviour in case of obstruction) are active and work as described in par. 3.1. for normal operation.

4 - SELECTING THE EVOLUS - EVOLUS-T WORK PROGRAM

To select the automatic door work program use the selector installed in the system.

LABEL is equipped with two models:

The EV-DSEL digital programmer and the EV-MSEL mechanical key selector.



EV-MSEL



EV-DSEL

4.1 - DIGITAL PROGRAMMER EV-DSEL



By pushing the central button  select the automatic door work mode.

Each time a button is pressed, it switches from a work program to the next one.

The various available programs are described below.

DOOR WORK PROGRAMS



The door opens by activating any installed opening control.



The external radar is deactivated, all other opening controls remain active.



The internal radar is deactivated, all other opening controls remain active.



The door opens and remains open permanently.



The door is closed and the radars are not active. The door may only be opened with the Emergency opening button.



The door's automatic mode is deactivated and the leaves can be moved manually.

REDUCED OPENING



Press the  button to reduce the passage opening.

The symbol  on the display indicates that the function is on. To turn off the reduced opening function, press the same button again.

PASSWORD

To prevent the set function from being modified, a password can be entered that must be input every time the digital programmer is used.

WARNING!

When enabling the password, be careful not to forget the access combination.

To enable the password, follow the steps described below.



From the work program display, press the  button for 8 seconds.

The programming menu will appear on the display.



Press the button  until accessing CODE, which corresponds to the password section.



Briefly press the  button to access password selection.
The current password is requested.



Enter the default password provided by LABEL with all digital programmers.
The default LABEL password is composed of 5 characters and is A-A-A-A-A.
Press the button in correspondence of the letter "A" and an asterisk will appear on the display in the field for the first letter.



Press the button in correspondence of the letter "A" a second time, and an asterisk will appear on the display in the field for the second letter.



Press the button in correspondence of the letter "A" a third time, and an asterisk will appear on the display in the field for the third letter.



Press the button in correspondence of the letter "A" a fourth time, and an asterisk will appear on the display in the field for the fourth letter.



Press the button in correspondence of the letter "A" a fifth time and a screen will appear on the display that asks whether to enable the password "ON" or disable the password "OFF" (if the button in correspondence of OFF is pressed, you will exit password selection and return to the programming menu)



If the ON button is pressed, a screen will appear on the display where the new password is requested. Now enter the desired password, selecting a combination of 5 characters from the letters A-B-C-D.

To select the letters, press the button in



After entering the password the first time, the combination must be repeated a second time. Enter the previous password again.



If the entered password is correct, the message "PASSWORD OK!!" will appear on the display.



The system will now automatically return to the main programming menu.



Press the  button for 3 seconds to exit the programming menu and return to the main work programming selection screen.

At this point, the password will be requested each time that the work program must be changed. Simply enter the selected combination to use the digital programmer. To change the password or disable it, repeat the previous operations.

4.2 MECHANICAL KEY SELECTOR EV-MSEL

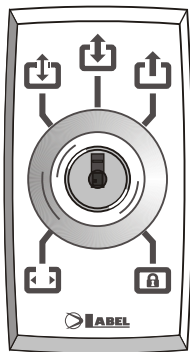





The **EV-MSEL** key mechanical selector permits to setup the work program of the automatic **EVOLUS** door.

It is equipped with a key switch allowing to lock the selected function by removing the key.

OPERATING MODE

Input and turn the key of the EV-MSEL selector to select the desired function among the 5 available functions:

-  **DOOR ALWAYS OPEN** = to keep the door open.
-  **WINTER OPENING** = to get a reduction of the opening space
-  **TWO-WAY TRAFFIC** = to open the door by means of all the control inputs
-  **OUTGOING TRAFFIC ONLY** = to exclude the incoming detection (EXTERNAL RADAR)
-  **NIGHT LOCK** = to keep the door closed, allowing its opening only by means of the EMERGENCY input

The key can be taken out of the selector when in any position in order to prevent the work program from undesired changes.

5 - OPERATION IN CASE OF POWER SUPPLY FAILURE

EVOLUS - EVOLUS T

If the **EV-BAT1** optional module is installed, automatic door operation is guaranteed by an emergency battery. Depending on the programming of the automation electronic control unit, the door may operate as follows:

- a) Automatically open and stay open if the program selector is not set to Night Lock.
- b) The door stays closed, but it can be opened by activating any opening command (motion sensors, buttons, etc.)

● POWER SUPPLY LIGHT DISPLAY ON EV-DSEL PROGRAMMER



Mains power supply on and connected battery being charged.



Mains power supply off and door operating with charged battery.



Mains power supply off and door operating with almost exhausted battery.

Mains power supply on with inefficient battery.

- When the battery is exhausted or there is no emergency battery, door motion is free and wings may be opened manually if the **EV-EBFSE** closing electric lock is not installed.
- If the **EV-EBFSE** electric lock is installed and the door is closed wings cannot be moved manually. In this case, to unlock the door, release the electric lock turning the **MANUAL RELEASE** knob clockwise by about 45° - 50° (see fig. below, position ②); under these conditions you can manually open the door.

① LOCKED



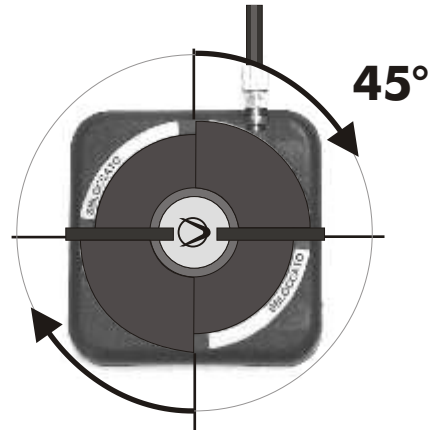

② RELEASED



Remember to turn the **MANUAL RELEASE** knob back to position ① LOCKED to restore the electric lock operation with mains power supply on.

6 - NOTIFICATION OF ERRORS AND OPERATION PROBLEMS

PROBLEM	LIKELY CAUSE	SOLUTION
The door beeps before opening and on the EV-DSEL programmer the  light is on.	Battery is defective and inefficient. The deviation in the automation behaviour when the problem is detected depends on the programming of the electronic control unit.	If the problem occurs when the mains power supply is off the battery might be getting exhausted. Wait for the restoration of the mains power supply. If the problem persists when the mains power supply is on, contact the service centre.
The door opens but it doesn't close and on the EV-DSEL programmer the  light is on.		
The door opens but it doesn't close back.	The motion sensors (radars) or the safety photocell detect the presence of an object or of a person.	Check that the radars or the photocells are not engaged.
The door stops during the stroke and inverts the running direction. During the next operation motion is slower.	The door detects an obstacle along its stroke.	Identify the obstacle and remove it.
	The fixture experiences friction along its stroke.	Properly arrange the fixture; for this operation please contact the service centre.
The electronic control units beeps multiple times and door operation is irregular.	The defect depends on the number and length of the beeps.	Contact the service centre to resolve the problem.

7 - MAINTENANCE

The maintenance plan must be observed to ensure the life and proper operation of the automatic door. LABEL offers a series of maintenance contracts providing for periodic intervention on the system by specialised technicians.

Offered services are:

- ▶ CHECK AND STABILITY OF FASTENERS;
- ▶ CHECK AND ADJUSTMENT OF THE TRACTION BELT;
- ▶ CLEANING OF THE CARRIAGE SLIDING RAILS AND OF THE GROUND GUIDE;
- ▶ CHECK OF CARRIAGES AND WING ALIGNMENT;
- ▶ PROPER POSITIONING AND FASTENING OF FINAL LEDGES;
- ▶ CHECK OF THE ELECTRIC LOCK AND OF THE MANUAL RELEASE OPERATION;
- ▶ CHECK, ADJUSTMENT (IF REQUIRED) AND CLEANING OF THE MOTION AND PRESENCE SENSORS
- ▶ CHECK OF WING MOTION SPEED AND FORCES;
- ▶ CHECK OF CONNECTIONS AND ELECTRIC WIRING;
- ▶ CHECK OF WING SLIDING SMOOTHNESS ALONG THE WHOLE STROKE;
- ▶ REPLACEMENT OF ANY SYSTEM COMPONENT FOUND TO BE DAMAGED OR WORN WITH GENUINE SPARE PARTS.

Each maintenance operation is recorded into the maintenance register.

The final user must limit himself to cleaning the glass surfaces, the fixture profiles and if necessary the motion and presence sensors, taking care to lock the door while performing these operations.

8 - DISPOSAL

At the end of its life, this system must be disposed of in accordance with national provisions. To this purpose we recommend that you contact specialised operators.

LABEL service centre



EVOLUS



LABEL S.p.A.
Via U. Ilariuzzi, 17/A - S.Pancrazio Pse - 43126 - Parma
Tel. (+39) 0521/6752 - Fax (+39) 0521/675222
www.labelsipa.com



AZIENDA CERTIFICATA
SISTEMA QUALITA'
UNI EN ISO 9001:2000