

USER MANUAL



PEDESTRIAN AUTOMATIC SLIDING DOOR

FOR ESCAPE ROUTES
and EMERGENCY EXITS



REVOLUS REVOLUS-T

16005



Made in Italy by



English
TRANSLATION OF ORIGINAL INSTRUCTIONS

RECOMMENDATIONS

THIS INSTRUCTION MANUAL IS INTENDED FOR THE FINAL USER OF A LABEL AUTOMATIC SLIDING DOOR SYSTEM; IT IS UNDERSTOOD THAT INSTALLATION AND TESTING MUST HAVE BEEN CARRIED OUT BY SPECIALISED PERSONNEL.

The person in charge of the automatic door commissioning must hand over this User Manual to the end user and inform him as to the automated equipment operation.

GENERAL SAFETY WARNINGS



BEFORE COMMISSIONING THE AUTOMATIC DOOR, PLEASE CAREFULLY READ THIS MANUAL.

PROVISIONS

The automatism has been designed to be used exclusively with pedestrian automatic sliding doors. The manufacturer accepts no responsibility for incorrect product usage, as well as for any damages arising from changes to the system made without his prior consent. When operating the system accident prevention regulations must be observed.



The installer must inform the owner of the automatic door as to the use of the primary password required to use the R-DSEL digital program selector and as to the procedure to be followed to modify the combination.

REMARKS

Always meet the usage and maintenance conditions provided for by LABEL. Maintenance and repair operations must only be performed by qualified and properly trained personnel.

PROPER BEHAVIOUR

Only use the automatic door if it is in perfect technical conditions. In case of failure or malfunction that might affect safety immediately contact the service centre. Inappropriate use of the system may cause serious injuries and damage.

AUTOMATIC SLIDING DOOR

FOR ESCAPE ROUTES AND EMERGENCY EXITS

models: **REV-D**
 REV-S
 REV-DTEL
 REV-TELDX
 REV-TELSX

TABLE OF CONTENTS:

1) INDICATIVE SYSTEM DESCRIPTION	page	4
2) TECHNICAL DATA		4
3) AUTOMATIC DOOR OPERATION		5
3.1) NORMAL DOOR OPERATION		5
3.2) DOOR OPERATION IN NIGHT LOCK MODE		5
3.3) SYSTEM SAFETY TEST DURING OPENING		5
4) R-DSEL DIGITAL PROGRAM SELECTOR		6
4.1) GENERAL PROGRAMMING MENU		8
4.2) PASSWORD		9
4.3) LANGUAGE		11
5) OPERATION IN CASE OF POWER SUPPLY FAILURE		12
6) NOTIFICATION OF ERRORS AND OPERATION PROBLEMS		13
7) MAINTENANCE		14
8) DISPOSAL		14

1) INDICATIVE SYSTEM DESCRIPTION

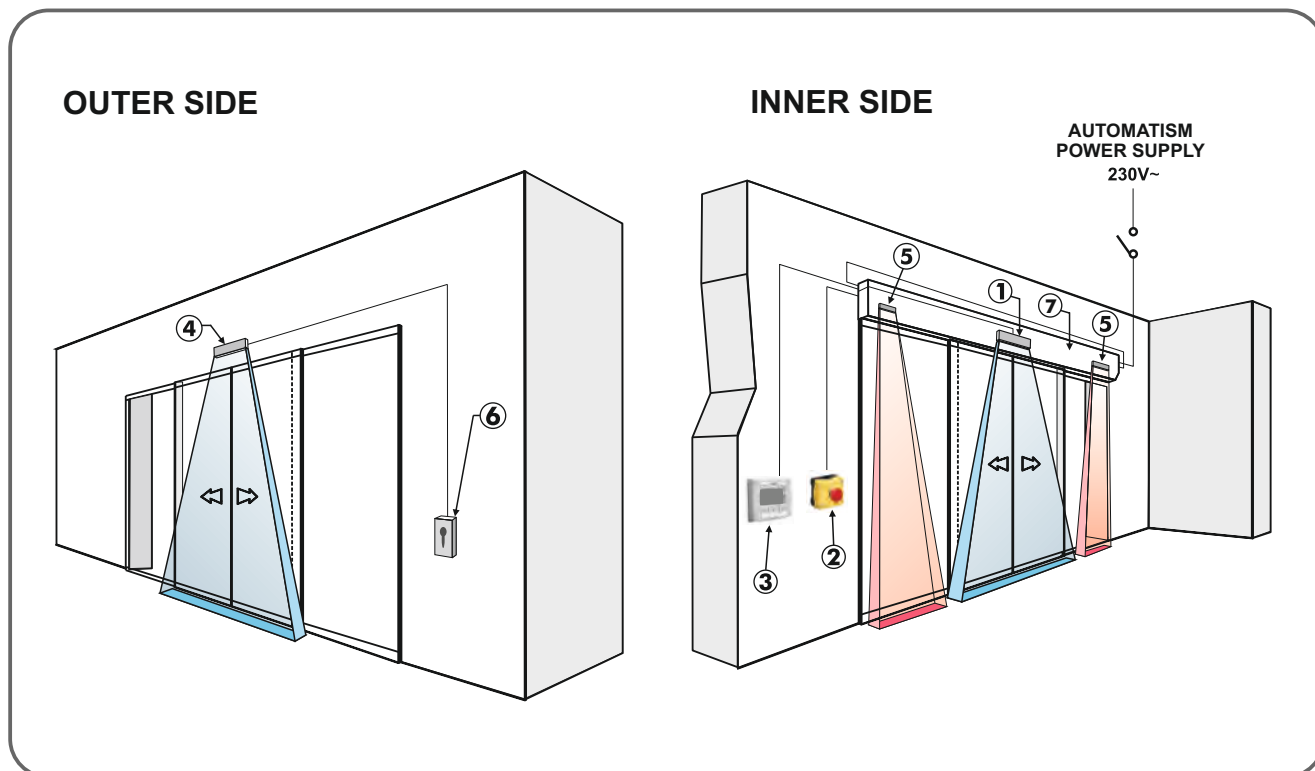

- ① Internal movement and presence sensor for door opening and safety during closing
- ② Emergency opening button
- ③ Digital programmer
- ④ External movement and presence sensor for door opening and safety during closing
- ⑤ Opening safety sensor
- ⑥ Key button
- ⑦ REVOLUS operator

2) REVOLUS - REVOLUS-T OPERATOR TECHNICAL DATA

OPERATOR MODEL	REV-D	REV-S	REV-DTEL	REV-DTELSX	REV-DTELDX
POWER SUPPLY	230Vac +/-10%, 50-60Hz				
POWER	100W				
STAND-BY CONSUMPTION	6W				
FREQUENCY OF USE	continuous				
PAUSE TIME	Max. 20 sec.				
WORKING TEMPERATURE	-15°C +50°C				
DEGREE OF PROTECTION	IP22				
POWER SUPPLY OF EXT. ACCESSORIES	24 Vdc				
REVOLUS TRANSOM DIMENSIONS (H x D)	120 x150 mm				
REVOLUS-T TRANSOM DIMENSIONS (H x D)	120 x210 mm				

3) AUTOMATIC DOOR OPERATION

WARNING!!

Always contact the assistance technician before commissioning the door, to learn how the automation works.

Switch on the power supply by means of the system switch.

The automation electronic control unit beeps shortly to indicate that the automatic door is powered; a calibration cycle starts automatically during which the door opening speed is very low until the end of the stroke, to find the stop point.

The door then closes back and again performs a full opening/closing cycle, during which the automated equipment carries out the safety system test.

Once the test is completed the door is ready for normal operation.

3.1) NORMAL DOOR OPERATION

When something enters the motions sensor (internal and/or external radar) detection area the door opens and stays open until sensors detect the presence, then once the pause delay has elapsed the door closes back.

When the manual door opening button is pressed the door opens and stays open until the command remains active, then once the pause delay has elapsed it closes back.

If the closing safety sensor detects a presence, the door immediately reopens, and stays open as long as the sensor remains engaged.

If the opening safety sensor detects a presence, the door, after opening to an extent corresponding to 80% of the passage opening, slows down and proceeds very slowly until the opening stroke is completed.

If during the opening movement the door bumps against an obstacle, it stops and tries to reopen if the radar detects a presence; if after three attempts the obstacle persists, the door stops, and will only close back when the internal radar is disengaged.

If during the closing motion the door bumps against an obstacle, it stops and opens back.

When it closes again, later, it slows down near the point where it had met the obstacle, to avoid further impact.

3.2) DOOR OPERATION IN NIGHT LOCK MODE

The door cannot be opened through the external and internal radars.

The door can only be opened by pressing the OPEN button, or using the Spyco radio-control, if any.

The safety function (sensors and behaviour in case of obstruction) are active and work as described in par. 3.1. for normal operation.

3.3) SYSTEM SAFETY TEST DURING OPENING

The automatic door performs the safety system testing operations whenever it is powered, whenever the NIGHT LOCK or MANUAL work programs are deselected and an automatic work program is selected, or once every 24 hours.

During the safety system s test the message "SAFETY SYSTEM TEST" is displayed on the digital programmer and the automatic door movement is achieved keeping active both command and safety inputs.

4) R-DSEL DIGITAL PROGRAM SELECTOR



Each time, before using the R-DSEL digital programmer, the user is prompted to enter the relevant password.
If no operations are performed for about 6 seconds, the R-DSEL programmer switches back to the stand-by mode and the user will have to enter the password again to use it.



By pulse-pressing the **SETA** button, choose the automatic door operating mode.
Each time a button is pressed, it switches from a work program to the next one.
The display sequentially shows the available work programs.

The operating programs to be selected by **SETA** button are described below



Bi-directional automatic program

The door automatically opens when each opening control activates.



Single-direction automatic program output only

To exclude the incoming detection on external radar input



Open door program

The door stops in complete opening position.



Night lock program

The door can only be opened through the OPEN input or using the remote control, if any.



When you select NIGHT LOCK, you will be prompted to confirm the operation; press F3 to confirm, or another button to cancel.



Free manual door

The automatic operation is disabled and door can be manually open.



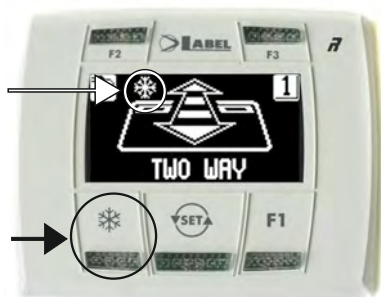

When you select MANUAL, you will be prompted to confirm the operation; press F3 to confirm, or another button to cancel.

Operation of other buttons located on R-DSEL program selector panel



REDUCED OPENING DURING WINTER

To reduce the passage opening.

To activate the reduced opening during winter press the  button once; the  symbol on the display indicates that the function is on.

To disable the reduced opening during winter press the  button once more.



F1

Door opening command

Pressing the F1 button will open the door.

The F1 may open the door even when the "NIGHT LOCK" work program is selected, if the operator electronic control unit is set accordingly.

You can set whether the F1 button shall work right away when it is pressed or only after the user password has been typed (see paragraph "F1 BUTTON PASSWORD").



F3

It is used to confirm the NIGHT LOCK or MANUAL work program



When switching back from the NIGHT LOCK or MANUAL program to the automatic program, the operator carries out the safety system test.

While the opening safety system test the message "SAFETY SYSTEM TEST" is displayed on the R-DSEL.

4.1) GENERAL PROGRAMMING MENU

The user can enter the general programming menu when he wishes to select the desired language for the texts that appear on the display, or when he wishes to modify the password to prevent any unauthorised access to the R-DSEL digital programmer.

DIAGRAM 1

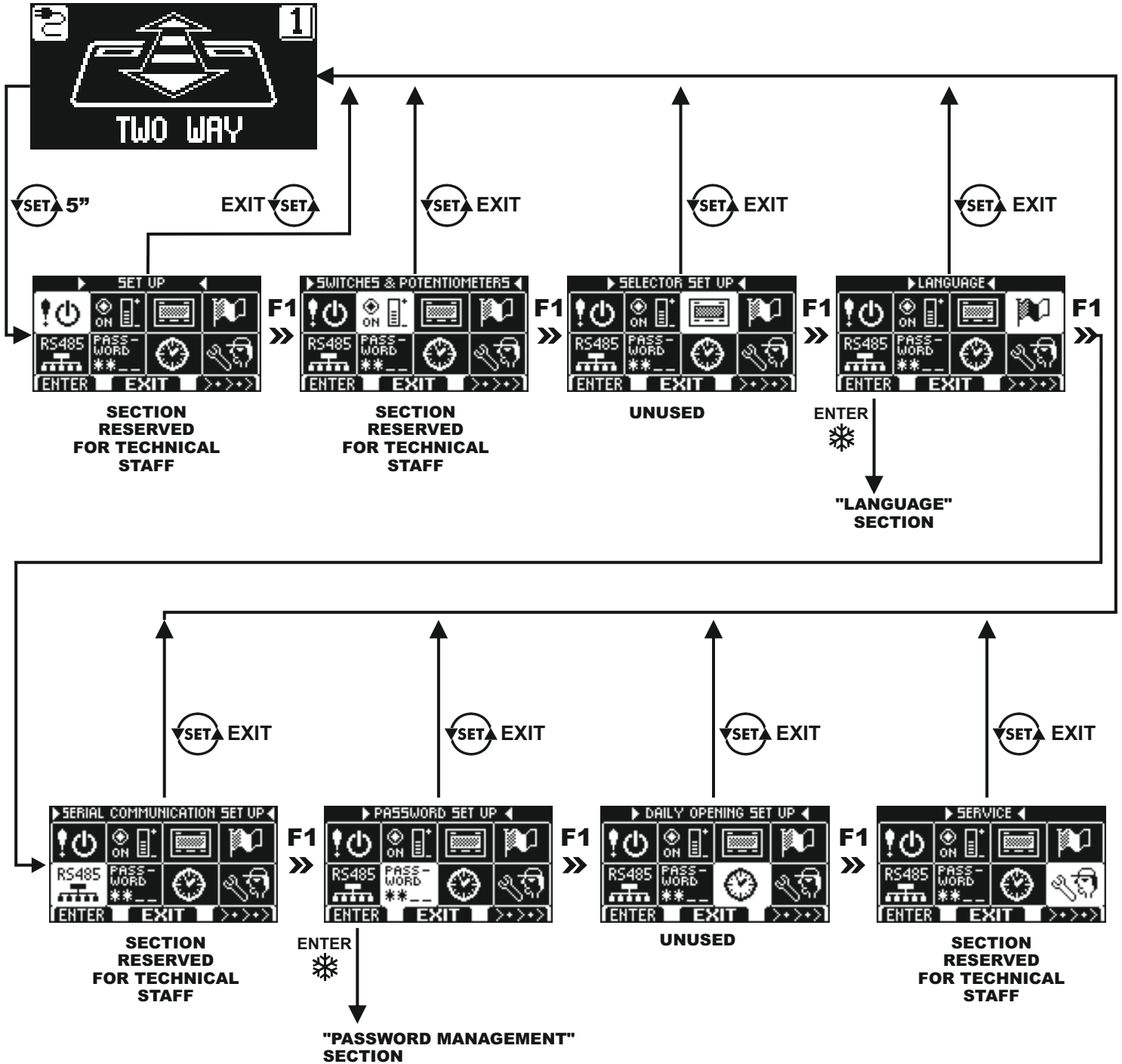

The paragraphs below explain the procedure to be followed to manage the user password and to select the language.

4.2) PASSWORD

To prevent the door work program from being modified by unauthorized persons, the password must be entered every time the R-DSEL programmer is used.

To access the "PASSWORD MANAGEMENT" section perform the following operations:

1. Press the SET button for 5 seconds to access the general programming menu (see Diagram 1 at para. 4.2.1)
2. Press the F1 button five times to switch to the Password Management sub-menu.
3. Press the Enter  button to access the "Password management" section.

PASSWORD MANAGEMENT



The password the end user must type is the primary password.

The technical password is only reserved for the technical staff members in charge of installation and maintenance operations.

PRIMARY PASSWORD (for the system's owner-user)

It is a 5-character password used by the user to prevent unauthorized persons from having access to R-DSEL programmer and change the work program.

Default preset primary password is "A-A-A-A-A".

WARNING!

After changing the password, be very careful not to forget it!

Use the  button to move the selection arrow downward, the F2 button to move back upward.

HOW TO CHANGE THE PRIMARY PASSWORD

- Select "PRIMARY PASSWORD"
- Press OK (F1) button.



- Type the default preset primary password "A-A-A-A-A" by pressing 5 times on A button.
(If the primary password is not the default password as it had already been changed before, type the currently-used primary password).



- Type the new primary password, selecting a combination of 5 characters from the letters A-B-C-D.



- It is required to repeat the new password, so type the previous combination again.



- If the typed password is correct the "PASSWORD OK" message appears on the display for one second, then the system switches back to the PASSWORD MANAGEMENT section; press the EXIT  button to return to the general programming menu
- If the typed password doesn't match the previous one, the PASSWORD ERROR message appears on the display; the system will switch back to the PASSWORD MANAGEMENT section and the user will have to repeat the procedure.



WRITE DOWN THE 5-CHARACTER PRIMARY PASSWORD IN THIS BOX:

— — — — —

F1 BUTTON PASSWORD

- Select "F1 BUTTON PASSWORD"
- Press OK (F1) button.



- Press the ON  button to enable the prompting of the user password before the door opens when the F1 button is pressed and return to the PASSWORD MANAGEMENT menu.
To return to the work program view press the EXIT  button twice.
- From now on whenever the user wishes to open the door by pressing the F1 button he will have to type the primary password.

DISABLING THE F1 BUTTON PASSWORD USAGE

- From the PASSWORD MANAGEMENT section, select "F1 BUTTON PASSWORD"
- Press OK (F1) button.

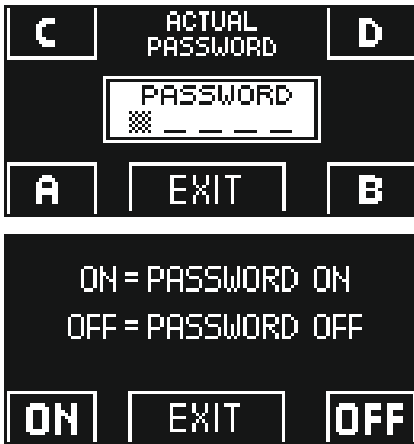





- Type the primary password

- Press the OFF (F1) button to disable the prompting of the user password before the door opens when the F1 button is pressed.
To return to the general programming menu press the EXIT  button twice
From now on the door can be opened by pressing the F1 button once.

4.3) LANGUAGE

To select the language perform the operations listed below:

1. Press the EXIT  button for 5 seconds to enter the general programming menu. (see Diagram 1 in the previous paragraph)
 2. Press the F1 three times to switch to the "Language" sub-menu.
 3. Press the Enter  button to access the "Language" section.
- Use the F2 and  buttons to move arrow to the desired language.
 - Press the EXIT  button to return to general programming menu.
 - Press the EXIT  button again to return to the main view of the automatic door work program.



5 - OPERATION IN CASE OF POWER SUPPLY FAILURE

When any automatic program is selected, in case of mains power supply failure, the door opens using the power provided by the battery and stays open.

When NIGHT LOCK is selected the door stays closed.

In case of mains power supply failure, the operator switches off to preserve the battery charge.

- When the power supply is cut off, door motion is free and wings may be opened manually if the closing electric lock is not installed.
- If the electric lock is installed and the door is closed, wings cannot be moved manually. In this case, to free the door, release the electric lock by turning the MANUAL RELEASE knob by approximately 45° - 50° (see the figure below, position ②) clockwise; under these conditions you can manually open the door.

① LOCKED



② RELEASED

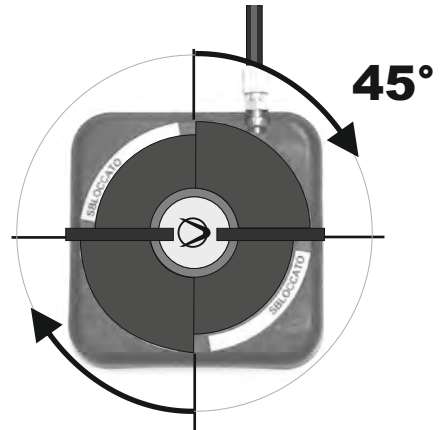

Remember to turn the MANUAL RELEASE knob back to position ① LOCKED to restore the electric lock operation with mains power supply on.

PROBLEM	LIKELY CAUSE	SOLUTION
The door opens but it doesn't close back.	The motion radars or the closing safety sensor detect the presence of an object or of a person.	Check that the radars or the sensors are not engaged.
The door opens very slowly when approaching the final section of the opening stroke.	The opening safety sensor detects an obstacle.	Identify the obstacle and remove it.
The door doesn't respond to the opening commands.	The MANUAL FREE DOOR function can be activated.	Check the setting of the program selector.
The door stops during the stroke and inverts the running direction.	The door detects an obstacle along its stroke.	Identify the obstacle and remove it.
	The fixture experiences friction along its stroke.	Properly arrange the fixture; for this operation please contact the service centre.
The electronic control units beeps multiple times and door operation is irregular.	The defect depends on the number and length of the beeps.	Contact the service centre to resolve the problem.
The  symbol appears on the display	The system has detected a machine operation error.	Contact the service centre to resolve the problem.
The door has opened and doesn't close back. The message "SAFETY SYSTEM ERROR" is displayed on the R-DSEL programmer.	The automated equipment has detected a safety system fault during opening.	Try to select the NIGHT LOCK program and then to return to the automatic program. Should the problem persist, please contact the support centre.

Should any malfunction occur, the Customer must contact the Support Centre and use the door manually, without powering it.

7 - MAINTENANCE

The maintenance plan must be observed to ensure the life and safe operation of the automatic door. We recommend that you sign a maintenance contract providing for periodic intervention on the system by specialised technicians.

User will be warned that the maintenance interval has expired when the message "PROGRAMMED MAINTENANCE" message is shown on the display.

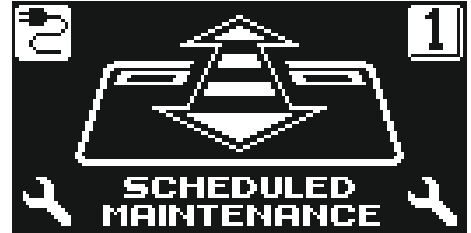

Each maintenance operation is recorded into the maintenance register. The final user must limit himself to cleaning the glass surfaces, the fixture profiles and if necessary the motion and presence sensors, taking care to lock the door while performing these operations.

8 - DISPOSAL

At the end of its life, this system must be disposed of in accordance with national provisions. To this purpose we recommend that you contact specialised operators.

LABEL service centre

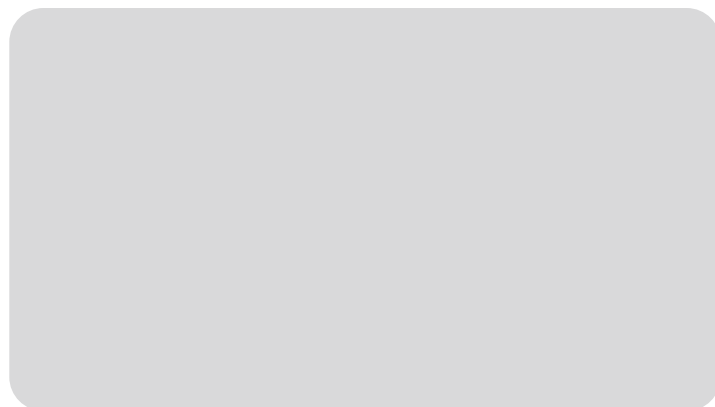

REVOLUS

Made in Italy

by



Via Ilariuzzi, 17/A - S. Pancrazio P.se - 43126 PARMA - ITALIA
Tel. (+39) 05 21/ 67 52 - Fax (+39) 05 21/ 67 52 22
infocom@labelspa.it - www.labelspa.com

